



U
O
Y
A
G
E
R
ONE

IMPORTANTE

**É DE EXTREMA IMPORTÂNCIA LER, COMPREENDER E
SEGUIR TODAS AS INSTRUÇÕES CONTIDAS NESTE MANUAL. O MANUSEIO
INCORRETO PODE DANIFICAR O EQUIPAMENTO E OCASIONAR
A ANULAÇÃO DA GARANTIA.**









VISÃO GERAL BLACK



VISÃO GERAL WHITE



ACESSÓRIOS :

Item	Nome / Quant.	Utilidade
	Abraçadeiras x5	Organização dos Cabos
	Espaçadores #6-32 6.5mm x4	Suporte para Placa-Mãe
	Parafusos M3 5mm x20	Placa-Mãe e SSD 2.5"
	Parafusos #6-32 6mm x6	Fonte de Alimentação e Placa de Vídeo
	Parafusos #6-32 5mm x4	HDD 3.5"
	Parafusos M3 28mm x8	Parafuso das Ventoinhas
	Pilar de Cobre x1	Suporte para Fixação dos Espaçadores
	Capa traseira I/O x1	Slot de Expansão
	Fivela de Plástico x2	Organização dos Cabos

PAINÉIS E FONTE DE ALIMENTAÇÃO :

Remova os painéis laterais antes de remover o painel frontal.

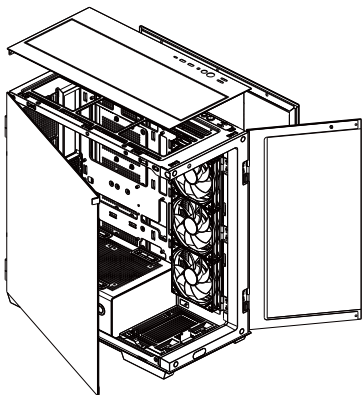

Acesse o suporte da Fonte através da lateral direita do gabinete, posicione a Fonte de Alimentação alinhando suas furações com as do gabinete, fixe-a com os respectivos parafusos pela parte traseira do gabinete.

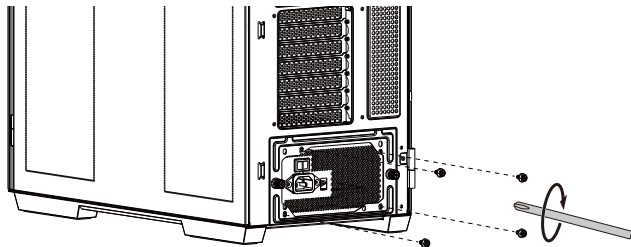

Parafusos #6-32 6mm
x6

PLACA-MÃE, VENTOINHAS E WATER COOLERS :

Através da lateral esquerda do gabinete, posicione a Placa-Mãe, alinhando suas furações com os espaçadores do gabinete, e fixe com os respectivos parafusos.



Parafusos M3 5mm
x20

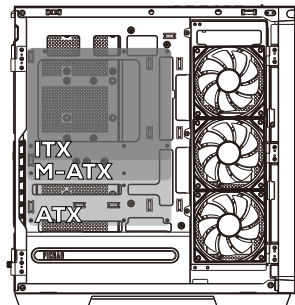

Espaçadores #6-32 6.5mm
x4

Suporte para
Placa-Mãe

SUPORE PARA VENTOINHAS:

Superior: 2x 140mm ou 3x 120mm.

Traseira: 1x 120mm.

Suporte Articulado: 3x 120mm.

Inferior: 3x 120mm.

SUPORE PARA WATER COOLER:

Superior: 240/280/360mm.

Traseira: 120mm.

Suporte Articulado: 240/360mm.

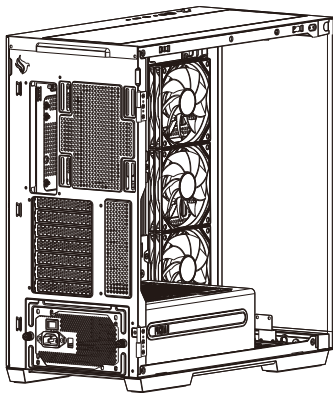

SUPOORTE DE HDD 3.5" E SSD 2.5" :

Acesse o suporte de HDD 3.5" e SSD 2.5" através do painel lateral direito do gabinete.

Desparafuse os 2 parafusos indicados na imagem ao lado para abrir o suporte.

Suporte para 2x SSD 2.5" + 2x HDD 3.5"

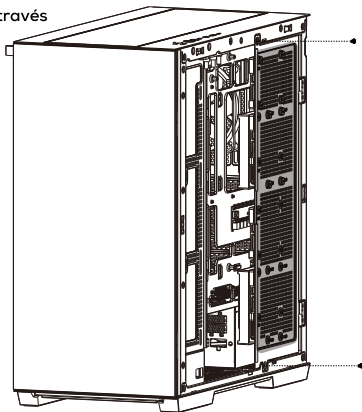

Posicione o SSD na parte interna do suporte, alinhando as furações com as do suporte, e fixe-o com os respectivos parafusos pela parte externa, conforme mostra a imagem.



Parafusos M3 5mm
x20

Placa-mãe e SSD 2.5"

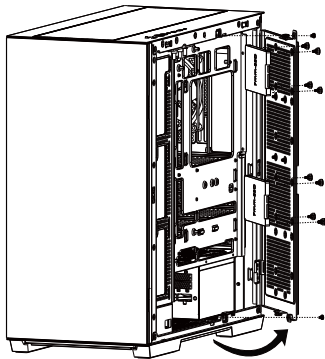

HDDs 3.5" E PLACA DE VÍDEO :

Posicione o HDD na parte interna do suporte, alinhando as furações com as do suporte, e fixe-o com os respectivos parafusos pela parte externa, conforme mostra a imagem.



Parafusos #6-32 5mm
x4

HDD 3.5"

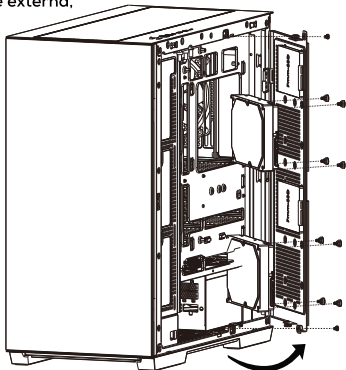

É possível instalar a Placa de Vídeo em orientação horizontal ou vertical, basta desparafusar e fixar o suporte de slots de expansão traseiro conforme sua preferência.

Remova os slots de expansão que o modelo da Placa de Vídeo irá utilizar, posicione a Placa de Vídeo alinhando-a com os slots e a Placa Mãe, então fixe com os respectivos parafusos.

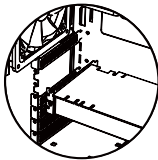
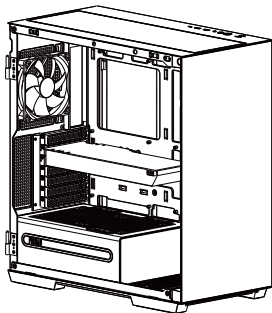

Parafusos #6-32 6mm
x6

Fonte de Alimentação
e Placa PCI-e

PAINEL SUPERIOR E CONECTORES :

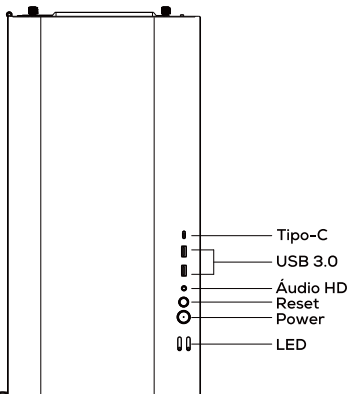

Conector de Áudio HD do Gabinete



Conector USB do Gabinete



Conector USB 3.0 do Gabinete



Conector de áudio HD da Placa-Mãe



Conector USB da Placa-Mãe



Conector USB 3.0 da Placa-Mãe

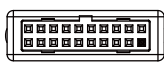

Conector TIPO-C



H.D.D LED

(GND)

+P LED

-P LED

(GND)

POWER SW

(GND)

Conector TIPO-C da Placa-Mãe

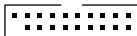

**AGRADECEMOS POR ESCOLHER A PICHAU GROUP.
COM O GABINETE VOYAGER ONE, SUA EXPERIÊNCIA
GAMER ALCANÇARÁ O INEXPLORÁVEL.**

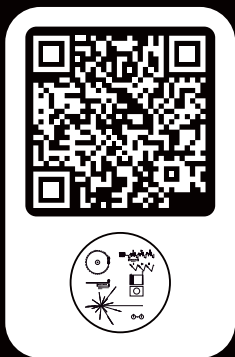

**EXPLORE NOSSOS SITES, CONHEÇA NOSSOS
PRODUTOS E AMPLIE SEUS HORIZONTES!**

